



Small Cubic Type

VGA CCD

Monochrome PoCL Camera Link Camera

FV-L030B1

Product Specifications

RICOH COMPANY, LTD.

Copyright & Disclaimer

Sensor Technology Co., Ltd. (DBA Sentech) believes the contents and specifications of its website, catalog, documentation and ads are correct; however, Sentech provides no representation or warranty regarding such information or product(s) contained therein. It is requested that Sentech be given appropriate acknowledgement in any subsequent use of such work by a third party.

While every effort has been made to ensure that the details contained in Sentech's website and all documentation are correct and up-to-date, Sentech assumes no liability, legal or otherwise for any errors in listings, specifications, part numbers, process, software or model applications. Sentech reserves the right to change specifications, product descriptions, product quality, pricing and application at any time without prior written or oral notice. Any party using such information assumes all risk for any and all damaged caused to themselves, a third party and/or property by virtue of incorrect information and/or failure of these products. By installing and/or using a Sentech software development kit or other similar product and/or information obtained from Sentech's website, catalog, documentation or ads, you hereby accept and understand these stated terms and conditions.

Table of Contents

1.	Safety / Product Precautions	4
2.	Electronic / Mechanical / Environmental Specifications	6
2.1	Spectral Sensitivity Characteristics.....	7
3.	Connector Specifications	8
3.1	Camera Link Connector.....	8
3.2	Power-I/O Connector	9
4.	Dimensions	10

1. Safety / Product Precautions

Safety Precautions

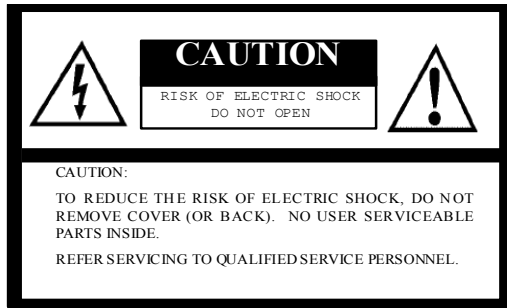

The lightning flash with arrowhead symbol, within an equilateral triangle, is intended to alert the user to the presence of uninsulated “dangerous voltage” within the product’s enclosure that may be of sufficient magnitude to constitute a risk of electric shock to persons.



The exclamation point within an equilateral triangle is intended to alert the user to the presence of important operating and maintenance (servicing) instructions in the literature accompanying the appliance.

For U.S.A.

Warning:

This equipment generates and uses radio frequency energy and if not installed and used properly, i.e., in strict accordance with the instruction manual, may cause harmful interference to radio communications. It has been tested and found to comply with the limits for a Class A computing device pursuant to Subpart J of Part 15 of FCC Rules, which are designed to provide reasonable protection against such interference when operated in a commercial environment.

For Canada

Warning:

This digital apparatus does not exceed the Class A limits for radio noise emissions from digital apparatus set out in the Radio Interference Regulations of the Canadian Department of Communications.

WARNING:

TO PREVENT FIRE OR SHOCK HAZARD, DO NOT EXPOSE THIS APPLIANCE TO RAIN OR MOISTURE.

Product Precautions

- Handle the camera with care. Do not abuse the camera. Avoid striking or shaking it. Improper handling or storage could damage the camera.
- Do not pull or damage the camera cable.
- During camera use, do not wrap the unit in any material. This will cause the internal temperature of the unit to increase.
- Do not expose the camera to moisture, or do not try to operate it in wet areas.
- Do not operate the camera beyond its temperature, humidity and power source ratings.
- While the camera is not being used, keep the lens or lens cap on the camera to prevent dust or contamination from getting in the CCD or filter area and scratching or damaging this area.
- Do not keep the camera under the following conditions:
 - In wet, moist, and high humidity areas
 - Under hot direct sunlight
 - In high temperature areas
 - Near an object that releases a strong magnetic or electric field
 - Areas with strong vibrations
- Apply the power that satisfies the requirements specified in this document to the camera.
- Use a soft cloth to clean the camera. Use pressured air spray to clean the surface of the glass. DO not scratch the surface of the glass.

RICOH

- The camera is a general-purpose electronic device; using the camera for the equipment that may threaten human life or cause dangers to human bodies directly in case of failure or malfunction of the camera is not guaranteed. Use the camera for special purposes at your own risk.

2. Electronic / Mechanical / Environmental Specifications

Product		FV-L030B1	
Electronic Specifications	Imager	1/3" Interline VGA Monochrome Progressive CCD: ICX424AL	
	Total Picture Elements	692 (H) x 504 (V)	
	Active Picture Elements	VGA: 648 (H) x 494 (V)	
	Cell Size	7.4 (H) x 7.4 (V) μ m	
	Scanning System	Progressive	
	Scanning Mode	Full Scanning, Partial Full Scanning, $\frac{1}{2}$ Partial Scanning, $\frac{1}{4}$ Partial Scanning, Variable Partial Scanning, Binning, Binning Partial Scanning, Binning $\frac{1}{2}$ Partial Scanning, Binning $\frac{1}{4}$ Partial Scanning, Binning Variable Partial Scanning	
	Vertical Frequency (Frame Rate)	31.47 (30fps) / 62.94 (60fps) / 94.784 (90fps) Hz in partial full scanning (default scanning mode)	
	Horizontal Frequency	15.7343 (30fps) / 31.4685 (60fps) / 47.2028 (90fps) kHz	
	Pixel Frequency	12.2727 (30fps) / 24.5454 (60fps) / 36.8181 (90fps) MHz	
	S/N Ratio (Standard Deviation @ 8bit output)	\leq 3 Digit (Gain 0 dB)	
	Minimum Scene Illumination	0.4 Lux at F1.2	
	Sync. System	Internal	
	Video Output Format	Digital 8, 10, or 12 bit Camera Link (Base Configuration)	
	Tap Configuration	1 Tap (1X-1Y)	
	Exposure Time		OFF, 1/3 to 1/40,000 sec. (Variable at every H and clock)(30fps)
			OFF, 1/7 to 1/80,000 sec. (Variable at every H and clock)(60fps)
			OFF, 1/11 to 1/120,000 sec. (Variable at every H and clock)(90fps)
	Gain	0 to 27 dB	
	Gamma	1.0	
	Smear Reduction	Selectable ON/OFF via the communication	
Power Supply	Input Voltage	DC 12V \pm 10% via Camera Link connector	
	Consumption	Less than 2.7W	
Operational Mode	Free-run; Edge Preset Trigger (V-reset, Non-reset); Pulse Width Trigger (V-reset, Non-reset)		
Communication	RS232 via Camera Link connector		
Mechanical Specifications	Dimensions	28 (W) x 28 (H) x 40 (D) mm (NOT including the connector)	
	Optical Filter	No IR cut filter	
	Materials	Aluminum (AC)	
	Lens Mount	C mount	
	Interface Connector	I/O Connector: HR 10A-7R-6PB (Hirose) or equivalent Camera Link Connector: SDR (3M) or equivalent	
	Tripod	Tripod can be attached to 4 plates (four M4 screws on the bottom plate, two M4 screws on the other 3 plates)	
	Weight	Approximately 43 g	
Environmental Specifications	Operational Temperature	Temperature: -5 to 50°C	

	Storage	Temperature: -30 to 65°C
Vibration	20Hz to 200Hz to 20Hz (5min./cycle); Acceleration 10G, 3 directions 30 min. each	
Shock	Acceleration 38G, half amplitude 6ms, 3 directions 3 times each	
Standard Compliancy	EMS: EN61000-6-2, EMI: EN55011 (Class B), FCC PART15 subpart B classA	
RoHS	RoHS Compliant	

2.1 Spectral Sensitivity Characteristics

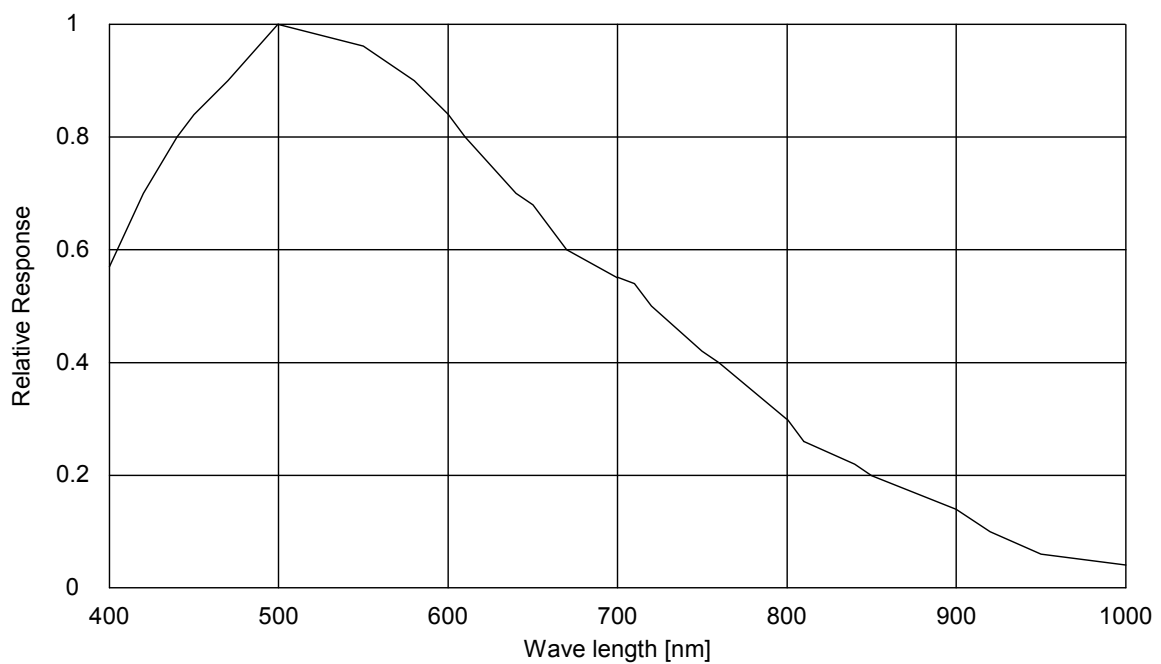

3. Connector Specifications

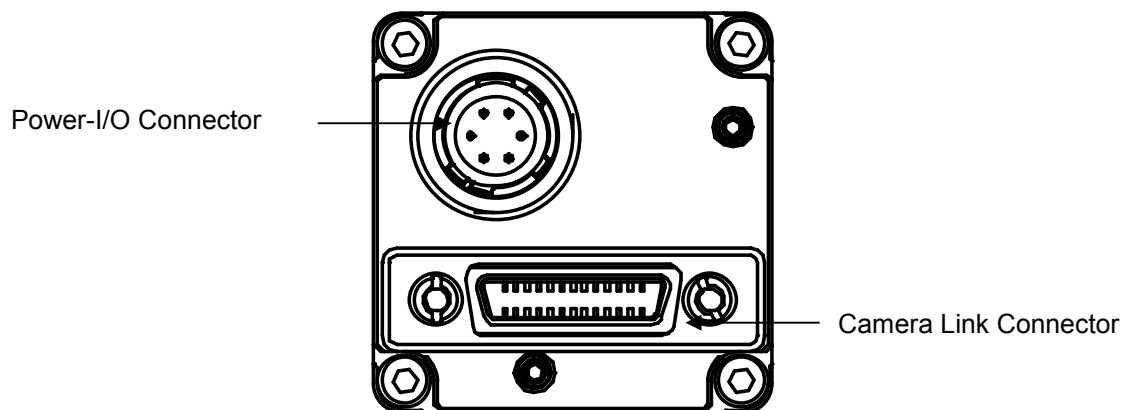

3.1 Camera Link Connector

SDR (3M) or equivalent

This product is a PoCL type.

When a frame grabber is PoCL compliant, DO NOT SUPPLY POWER FROM THE I/O CONNECTOR.

When a frame grabber is NOT PoCL compliant, supply power from the I/O connector.

Pin Assignment

Pin No.	Signal Name	Pin No.	Signal Name
1	+12V	14	GND
2	X0-	15	X0+
3	X1-	16	X1+
4	X2-	17	X2+
5	Xclk-	18	Xclk+
6	X3-	19	X3+
7	SerTC+	20	SerTC-
8	SerTFG-	21	SerTFG+
9	CC1-(TRG)	22	CC1+(TRG)
10	CC2+	23	CC2-
11	CC3-	24	CC3+
12	CC4+	25	CC4-
13	GND	26	+12V

3.2 Power-I/O Connector

- HR10A-7R-6PB (Hirose) or equivalent
- This connector is for the power supply (12Vdc) and input /output signals.
- Use HR10A-7P-6S (Hirose) or equivalent for the cable side.

Pin Assignment

Pin No.	Signal Name	IN / OUT	Voltage		
				Low Voltage	High Voltage
1	GND	IN	0V		
2	I/O-1	IN	0 to +0.5	+2.5 to +5.0V	
		OUT	0V	+3.3V	
3	I/O-2	IN	0 to +0.5	+2.5 to +5.0V	
		OUT	0V	+3.3V	
4	I/O-3	IN	0 to +0.5	+2.5 to +5.0V	
		OUT	0V	+3.3V	
5	I/O-4	IN	0 to +0.5	+2.5 to +5.0V	
		OUT	0V	+3.3V	
6	+12Vdc	IN	+12Vdc		

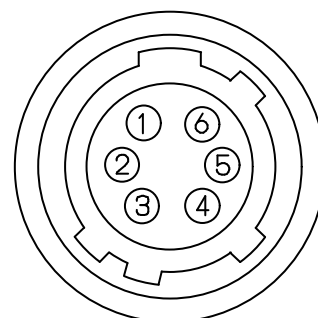

- Input/output signals can be assigned through the camera setting communication (see table 4).
- Trigger input signal can be assigned either on Camera Link connector (CC1) or on the No. 2 pin of the IO connector through the camera setting communication.

IO Signal Patterns

	Command No.		HR10A-7R-6PB (Hirose)			
	F0H[3..0]	11H[7]	No.2 Pin	No.3 Pin	No.4 Pin	No.5 Pin
			I/O-1 (SP4)	I/O-2 (SP3)	I/O-3 (SP2)	I/O-4 (SP1)
Option 0 (Initial Setting)	0H	0 (initial setting)	IN/TRG	IN/-	IN/-	OUT/ STROBE
		1	IN/TRG	OUT/VD	OUT/HD	OUT/ STROBE
Option 1	1H	-	For Test Use Only			
Option 2	2H	-	OUT/CC4	OUT/CC3	OUT/CC2	OUT/CC1
Option 3	3H	-	OUT/FVAL	OUT/XSG	OUT/XSUB	OUT/CC1
Option 4	4H	-	OUT/FVAL	OUT/LVAL	OUT/DVAL	OUT/PIC_D9 (MSB)
Option 5	5H	-	OUT/XHD (high-active)	OUT/EXPDUR (Exposure)	OUT/TRG	OUT/CC1
Option 6	6H	-	OUT/VD	N/A	N/A	OUT/HD
Others	7H-FH	-	For Test Use Only			

4. Dimensions

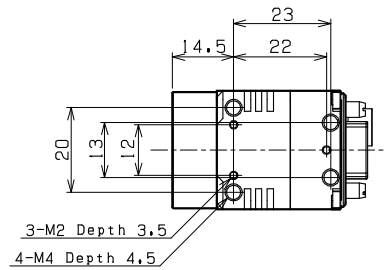
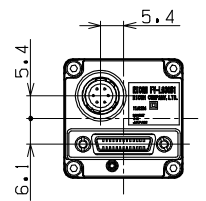
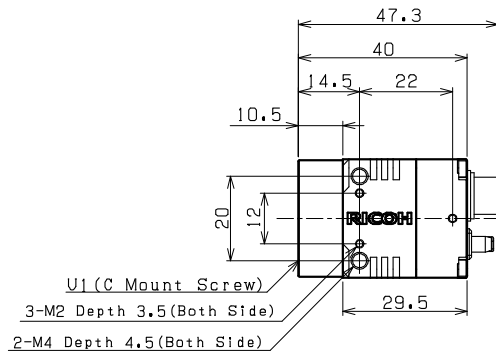
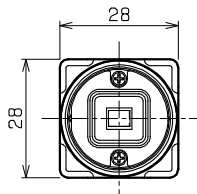
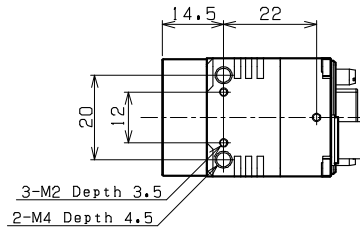
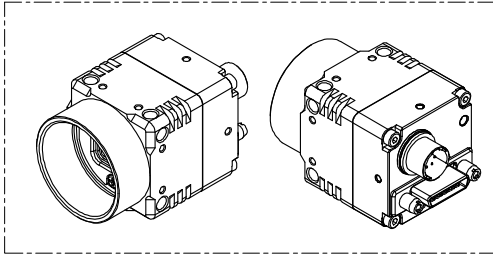

Unit: mm

Revision History

Rev	Date	Changes	Note
1.00	2012/06/15	● Initial Release	
1.01	2012/07/12	● Updated Document Title Electronic Specifications Shutter Speed → Exposure Time Added Smear Reduction Deleted F1H command due to test use only	

RICOH COMPANY, LTD.

URL http://www.ricoh.com/fa_security/